

Parking Assistance with ATmega16 Microcontroller

Dea Rizki Febrianti Tawakal and Erwin Sitompul

Study Program of Electrical Engineering, President University, Bekasi 17550, Indonesia

Corresponding author: dearizki_21@gmail.com

ABSTRACT

Nowadays safety becomes an increasing important factor in developing cars. Measures come in the form of physical strengthening and diagnostics improvement of the car. One way to improve the safety of a car is by implementing a car parking assistance. Although it already becomes a standard feature in some cars, the additional charge for the customers is still considerably high. This condition motivates the author to develop and implement a car parking assistance with affordable price and suitable for any types of car. The proposed system utilizes the ATmega16 Microcontroller and an ultrasonic sensor. The ultrasonic has a transmitter that produces a pulse in every 62.5 ms, and a receiver that detects the reflected pulse. The time of wave travel and thus the distance can be deduced. An LCD and a LED indicate the presence of object in front of the ultrasonic sensor. The resulting prototype proved that a car parking assistance can be made with low cost. Besides, it can be installed in any car with minimal adjustment.

Keywords: ultrasonic sensor, car parking assistance

ABSTRAK

Di masa kini faktor keamanan semakin mendapat perhatian dalam pengembangan mobil. Langkah-langkah dilakukan dalam peningkatan kekuatan fisik dan diagnosa perbaikan mobil. Suatu cara untuk meningkatkan keamanan mobil adalah melalui implementasi pemandu parkir mobil. Walaupun perangkat ini telah menjadi fitur baku di beberapa jenis mobil, biaya tambahan yang harus dikeluarkan oleh pelanggan masih cukup tinggi. Kondisi ini mendorong penulis untuk melakukan pengembangan dan implementasi suatu pemandu parkir mobil dengan harga yang terjangkau dan cocok untuk semua jenis mobil. Sistem yang diajukan menggunakan mikrokontroler ATmega16 dan sebuah sensor ultrasonik. Sensor ini memiliki sebuah pemancar yang membangkitkan pulsa setiap 62.5 ms dan sebuah penerima yang mendeteksi pulsa yang dipantulkan. Waktu tempuh gelombang dan jarak kemudian dapat ditentukan. Sebuah LCD dan sebuah LED dipergunakan sebagai indikator adanya benda di depan sensor ultrasonik. Purwarupa yang dihasilkan membuktikan bahwa pemandu parkir mobil dapat dibuat dengan biaya murah. Selain itu, perangkat ini dapat dipasang di semua jenis mobil dengan sedikit penyesuaian.

Kata kunci: sensor ultrasonik, pemandu parkir mobil

I. INTRODUCTION

As technology develops through its milestones, it impacts so many aspects in our life. Human always try to invent things that will make their life easier and more secure. Car as one of major inventions in means of transportation is also influenced by technology developments. More features and sensors are added so that a car can be operated with more ease and secure. One of them is car parking assistance.

When a driver has to park at a new environment or in a very limited space, a car parking assistance is a welcome aid, giving additional eyes to the driver. Besides relying on rearview mirrors, the driver will be given alert from the car parking assistance that will detect obstacles. The driver can then park the car safely.

By the time this research is conducted, the technology of car parking assistance is still relatively new. Thus, the additional price one must pay in order to buy a car equipped with this feature is still high. This motivates the author to design a car parking assistance device that can be made with affordable price. It should also be installable in any type of car and delivers the required functionality of such a device.

The proposed car parking assistance utilized the ATmega16 microcontroller as its brain, an ultrasonic transmitter-receiver as its sensor, and a buzzer as its actuator. For indicating purpose, LCD and LED are used. Working in frequency range of more than 20 kHz, the ultrasonic sensor is able to measure the distance between it and an object in front of it. Besides, it does not acoustically disturb any operation in the surrounding.

The buzzer will generate a warning sound if the detected distance is below a certain value. The LED is used

as a user interface, indicating the actual distance between the rear side of the car and the object behind it. The illustration of the car parking assistance is shown in Fig.1.

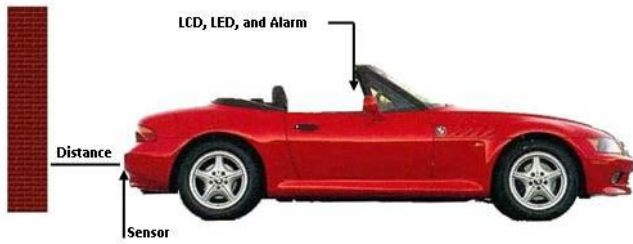

Figure 1. The illustration of car parking assistance

Only a few of similar parking system available in manufactured cars is equipped with exact distance indicator. This is one advantage of the proposed system.

II. DESIGN SPECIFICATIONS

The overall car parking assistance system proposed in this research is presented in Fig.2.

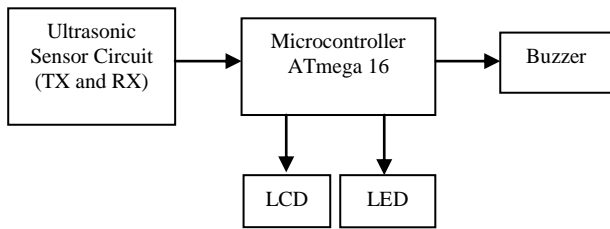

Figure 2. Block diagram of the proposed car parking assistance system

A. Ultrasonic Transmitter-Receiver

Ultrasonic applied to sound refers to anything above the frequencies of audible sound, and nominally includes anything over 20 kHz [And08]. The term ultrasound is also commonly used interchangeably. As we consider mechanical sound wave, ultrasound can travel in a solid, liquid, or gas medium. The frequency used by the ultrasonic sensor is at the range of 40-50 kHz.

The utilization of ultrasound to locate objects has the same working principle as RADAR (radio detection and ranging). The distance to an object can be determined by measuring the delay between the transmission of an ultrasound pulse and the return of its echo [Sia08]. The way an ultrasonic transmitter-receiver works can be observed in Fig.3.

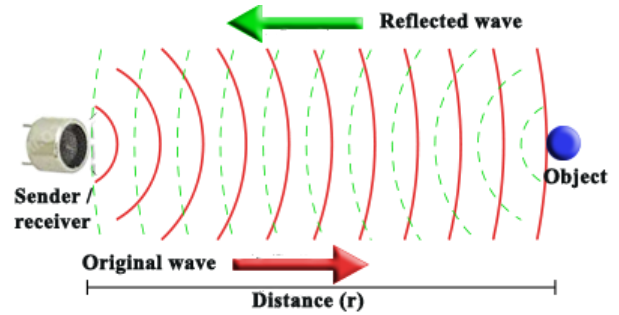

Figure 3. Principle of active sonar

One has to keep in mind, that the distance traveled is actually twice the distance r between the device and the object. The formula used to calculate the distance between the ultrasonic sensor and the object is given in Eq.1, with the speed of sound can be taken as 340.29 m/s.

$$r = \frac{\text{elapsed time} \times \text{speed of sound}}{2} \quad (1)$$

In this research, the author uses a compact one-piece ultrasonic transmitter-receiver, consists of a transmitter that transform electric energy into ultrasonic pulses and a receiver that transforms ultrasonic pulses into electric energy. An example of ultrasonic transmitter-receiver set is made of SCM 401 transmitter and SCS 401 receiver, as seen in Fig.4.



Figure 4. Ultrasonic transducer sensor set

B. Liquid Crystal Display (LCD)

LCD is made from liquid crystal material and uses dot matrix system in the operation. As many as 16 characters can be contained in each of the two lines. This LCD can connect easily with the microcontroller ATmega16 [MiS14].

A standard LCD requires 3 control lines as well as either 4 or 8 I/O lines for the data bus. The user may decide whether the LCD is operated with a 4-bit data bus or an 8-bit data bus. If a 4-bit data bus is used, the LCD will require 7 data lines (3 control lines plus 4 lines for the data bus). If an 8-bit data bus is used, the LCD will require 11 data lines (3 control lines plus the 8 lines for the data bus). The author uses an 8-bit data bus with 11 data lines. Fig.5 shows the LCD used in this project.



Figure 5. Liquid Crystal Display (LCD)

C. Light Emitting Diode (LED)

The function of LED is to emit light when electric current passes through it. LED must be connected in a correct way. Fig.6 shows the diagram of a diode labeled a or + for anode and k or – for cathode [AIH12]. The cathode is the short lead and there may be a slight flat on the body of round LED. The schematic diagram is also given on Fig.6.

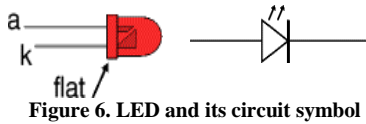

Figure 6. LED and its circuit symbol

D. Buzzer

A buzzer, as can be seen in Fig.7, is a part of car parking assistance system that has a function to generate sound when the distance is lower than the minimum allowed distance, set to be 30 cm. When the microcontroller gives logic 1, the buzzer will be on, and otherwise off.



Figure 7. Buzzer

E. ATmega16 Microcontroller

The ATmega16 microcontroller is the brain of the proposed system (see Fig.8). It organizes and leads all parts of the system. The ATmega16 itself is a low power, high-performance 8-bit microcontroller with 16 kbytes of in-system programmable flash and with true read-while-write capabilities. The on-chip ISP flash allows the program memory to be reprogrammed in the system through an SPI serial interface. The ATmega16 is a powerful microcontroller that provides a highly flexible and cost effective solution to many embedded control applications. The ATmega16 supports C compilers, macro assemblers, program debugger/simulators, in-circuit emulators, and evaluation kits [Atm10].



Figure 8. ATmega16

ATmega16 provides the following standard features: 16 kbytes of flash memory, 1 kbytes of internal SRAM, 32 general purposes I/O lines, 32x8 general-purpose working registers, internal and external interrupt sources, an SPI serial port, internal calibrated RC oscillator and 6 software selectable power saving modes.

III. DESIGN IMPLEMENTATION

A. Ultrasonic Transmitter-Receiver Circuit

The ultrasonic transmitter-receiver plays an important role in sensing the existence of obstacle and in measuring the distance of the obstacle to the sensor.

The transmitter circuit has a function to transmit ultrasonic pulses that will be received by the receiver circuit. This circuit is built of a hex inverter, a 220 nF capacitor and an ultrasonic transmitter. The microcontroller unit will generate ultrasonic pulses in the frequency of 40 kHz and magnitude of 5 V.

The hex inverter contains six NOT gates. In the implemented digital circuit, they are able to amplify the ultrasonic pulses generated by the microcontroller. Four out of six NOT gates are connected in parallel, as can be seen in Fig.9. Before feeding the output of the gates to the ultrasonic transmitter, the output is fed to a coupling capacitor (220 nF).

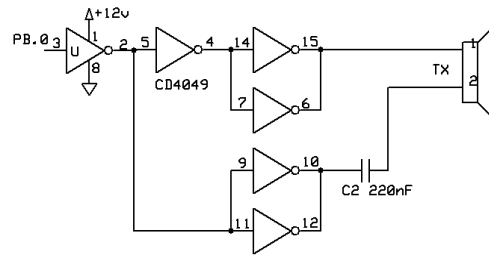

Figure 9. Schematic diagram of the transmitter circuit

The receiver circuit functions to receive the ultrasonic pulses transmitted from the transmitter circuit. This circuit has an ability to amplify, and compare the incoming ultrasonic pulses. Fig. 10 shows the schematic diagram of the receiver circuit.

When the ultrasonic pulses sent by the transmitter circuit hit the object, the pulses will be reflected back and captured by the receiver circuit. This signal is fed to a coupling capacitor (110 nF) to filter interference noise of the pulse. Afterwards, the pulses will be amplified twice by two transistors connected in series.

The detected pulses are conducted to a simple op-amp circuit functioning as a comparator of consecutive pulses. After compared, those pulses are fed into the ATmega16 microcontroller so that it can calculate the distance.

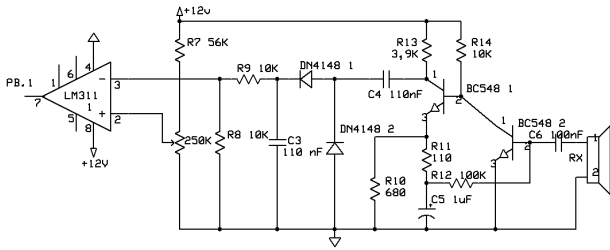

Figure 10. Schematic diagram of the receiver circuit

B. LCD Circuit

LCD has a function to show the distance measured between the ultrasonic transmitter-receiver and the obstacle in front of it. The circuit diagram of the LCD system can be seen in Fig.11.

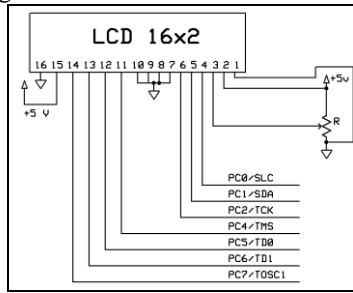

Figure 11. Schematic diagram of the LCD circuit

C. LED array circuit

The LED array circuit has the function to light on when the specified distance range is reached. The connections of the LED array circuit can be seen in Fig.12. The various distance ranges and the corresponding color of the LED that will turn on are shown in Table 1.

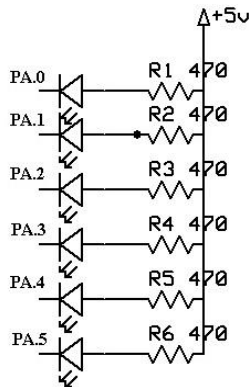

Figure 12. Schematic diagram of the LED array circuit

D. Buzzer circuit

As the distance of the obstacle is reaching 30 cm or closer, the buzzer will generate sound to inform that the distance is not safe anymore. This circuit is constructed of a buzzer that operates with +12 VDC, a transistor and a 10 kΩ resistor as shown in Fig.13.

Table 1. Distance Intervals and Corresponding Lighted LEDs

Distance Interval (cm)	Lighted LEDs
------------------------	--------------

0 – 30	1	2	3	4	5	6
30 – 40	1	2	3	4	5	
40 – 55	1	2	3	4		
55 – 70	1	2	3			
70 – 85	1	2				
85 – 100	1					

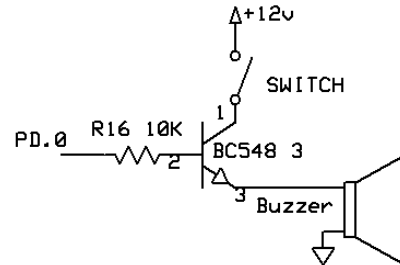

Figure 13. Schematic diagram of the buzzer circuit

Actually the buzzer can work perfectly even without additional circuit. Nevertheless, since the microcontroller can only give maximum output of +5 V, the author decided to connect the ATmega16 microcontroller with a circuit of transistor and resistor in series, so that the voltage fed to the buzzer circuit can be controlled.

When the ATmega16 microcontroller gives logic 1 (enable) to activate the transistor, it will drive the transistor and let the voltage of +12 V feed the buzzer. In order to make the device more convenient, a switch is installed in this alarm circuit. In case someone gets annoyed with the sound of the buzzer, she can switch off the alarm manually.

IV. RESULT AND ANALYSIS

A. Result

Before implementing the designed circuit, the author performed a simulation using Proteus software. The Proteus software has the ability to simulate the software part (microcomputer programming) and/or the hardware part (circuits of microcontroller, ultrasonic transmitter-receiver, buzzer, LED, and LCD) of circuit. Fig.14 depicts the simulation result of the overall system, using Proteus software.

The most important feature in doing the simulation in Proteus is its ability to simulate the interaction between the program running on a microcontroller and any analog or digital electronics connected to it. The microcontroller model sits on the schematic along with the other components of the design. It simulates the execution of machine code. If the program code writes to a certain port of the microcontroller, the logic levels in circuit change accordingly. If the circuit changes the state of a microcontroller pin, this will be detected by our program code. By using the Proteus ability, the author can easily simulate the overall system before comprehending the prototype of the car parking assistance system. The

simulation delivered good result and it shows that the system works well. The prototype of the system can be seen in Fig.15.

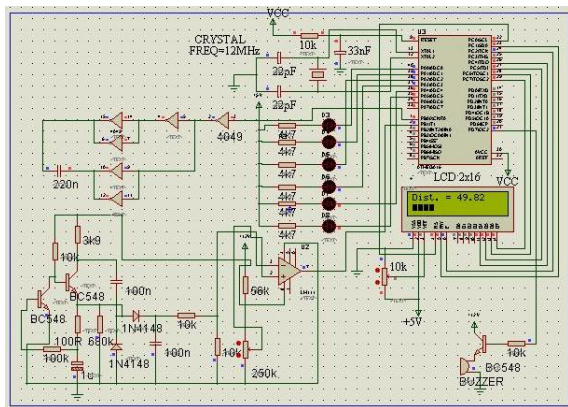

Figure 14. Preview of simulation result in Proteus software

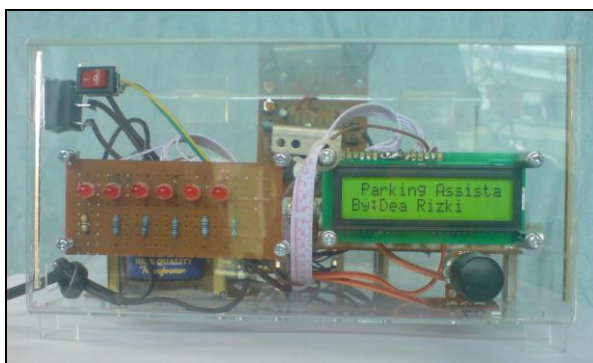

Figure 15. The implementation result of the car parking assistance

B. Analysis

Firstly, the results between the simulation and the real implementation of the car parking assistance system will be analyzed.

In the *Proteus* software, the ultrasonic transmitter-receiver is not available in the library. Due to this condition, the author used the other way in simulating the system. The wire where the ultrasonic sensor is placed is connected to a signal generator. By doing so, the LCD and the LED, and alarm can still work well. This is based on the fact that the ultrasonic sensor has a function to give the signal/ voltage through the receiver circuit from the transmitter circuit. It is possible because the microcontroller still can measure the distance from the signal that received by the receiver.

The real implementation of the system, as shown in Fig.15, is able to measure the distance. The real system works well and provides an affordable car parking assistant system that can be implemented in the car.

Secondly, the author experimented with two types of ultrasonic transmitter-receiver: the one with bigger size and smaller size. Those two kinds of components have the same way of work and operation with the difference only in size. The bigger one is proved to be more appropriate for the distance measurement. The bigger diameter that it has enables wider spread of the ultrasonic pulses.

V. CONCLUSION

Based on the design, simulation, and implementation of the project, several points can be concluded. The proposed and implemented system works well and satisfactorily. It can give the information regarding to the presence of an obstacle and the distance of the obstacle to the ultrasonic transmitter-receiver.

The implementation of the car parking assistance by using the combination of ATmega16 microcontroller and the ultrasonic transmitter-receiver acquired an additional benefit in which it pledges an affordable and fully functional device. This device can be implemented in various types of car without requiring fundamental adjustments

The maximum distance that can be sensed by the car parking assistant system is limited to 1 m. This is adequate, since for the purpose of parking system, the user does not need to detect a distance further than 1 m.

REFERENCES

- [And08] H. Andrianto, "Pemrograman Mikrokontroler AVR ATMEGA16 Menggunakan Bahasa C (CodeVisionAVR)", Bandung: Informatika, 2008.
- [Sia08] E. L. Sianturi, "Design and Implementation of Car Alarm system with the incorporation of motion sensor", Final Project Report, President University, Cikarang, Indonesia, 2008.
- [MiS14] S. Mishra and B. Singh, "Graphical LCD Oscilloscope using ATmega16 Microcontroller", International Journal of Information & Computation Technology, vol. 4, no. 14, pp.1467-1472, 2014.
- [AIH12] D. G. Alciatore and M. B. Histan, "Introduction to Mechatronics and Measurement Systems", ed. 4, McGraw-Hill, 2012.
- [Atm10] Atmel Corporation, "ATmega16 Microcontroller Manual", San Jose, 2010.