

## DAFTAR PUSTAKA

- Badi. (2021, May 16). *Sensor LDR : Pengertian, Simbol, Fungsi, Cara Kerja, Karakteristik*. Retrieved from Thecityfoundry: <https://thecityfoundry.com/sensor-ldr/>
- Nur Apipah Harahap. (2018). *Perancangan Prototype Jemuran Menggunakan Sensor Air Dan Sensor LDR Berbasis Mikrokontroler Arduino Uno Dengan Metode FLC*. *Media Informatika Budidarma*, Vol 2, No 1, Januari 2018, 15-25. <http://dx.doi.org/10.30865/mib.v2i1.814>
- Hendrian, Y., Yudatama, Y. P., & Pratama, V. S. (2020). *Jemuran Otomatis Menggunakan Sensor LDR, Rain drop sensor Dan Sensor Kelembaban Berbasis Arduino Uno*. *Volume VI No.1 Januari 2020*, 21-30.
- Iksal, Suherman, & Sumiati. (2018). *Perancangan Sistem Kendali Otomatisasi On-Off Lampu Berbasis Arduino dan Borland Delphi*. *Seminar Nasional Rekayasa Teknologi Informasi*, 117-123.
- Jayafebra, W. M. (2017). *Smart Jemuran Atau Pelindung Otomatis Pada Jemuran Berbasis Mikrokontroler Arduino*. Yogyakarta: Universitas Islam Indonesia.
- Julianto, D. (2017). *Media Pembelajaran Trainer Motor Dc, Brushless, Servo, Dan Stepper Dengan Kendali Mikrokontroler Arduino Uno Pada Mata Pelajaran Teknik Mikroprosesor Di Smk Negeri 2 Depok Yogyakarta*. Yogyakarta: Universitas Negeri Yogyakarta.
- Muhardi, Sari, W., & Irawan, Y. (2021). *Prototype Jemuran Otomatis Menggunakan Sensor Raindrop Dan Sensor Ldr Berbasis Arduino Nano*. *JIK*. 2021, 102 - 106.
- Nugroho, A. M., Hidayat, R., & Stefanie, A. (2021). *Implementasi Stepper 28BYJ-48 dan Servo MG996R sebagai Robot Lengan Pemanggang pada Alat Pemanggang Sate Otomatis Berbasis Arduino UNO*. *Volume 15, No.2, Mei 2021*, 96-99.
- Roghib, M. (2018, Oktober 2). *Program Motor Stepper*. Retrieved from Menara Ilmu Mikrokontroler FMIPA: <https://mikrokontroler.mipa.ugm.ac.id/2018/10/02/program-motor-stepper/>

*SIRAIT, A. C. (2020). Rancang Bangun Prototipe Jemuran Pakaian Otomatis Menggunakan Sensor Ldr Dan Rain Drop Sensor Md 0127 Berbasis Mikrokontroler Atmega 328 . Medan: Universitas Sumatra Utara.*

*Elly Mufida, Abdul Abas . (2 Juni 2017). Nformatics For Educators And Professionals. Alat Pengendali Atap Jemuran Otomatis Dengan Sensor Cahaya Dan Sensor Air Berbasiskan Mikrokontroler ATmega16, Vol.1, No. 2 Juni 2017, 163–172.*

*Muhammad Syarmuji, Sumpena Sumpena, Raden Muh Sultoji. Sistem Jemuran Otomatis Berbasis Arduino. Jurnal Teknologi Industri Vol. 11, Hal. 1 , 2022.*

*Wibowo, S. A., & Purnomo, H. (2017). Desain Produk Jemuran Anti Hujan Menggunakan Metode Quality Function Deployment (QFD). Sinergi Vol. 21, No. 2, Juni 2017, 141-148.*

# APPENDIX

## Lampiran 1. Rencana Kerja

SCHEDULE PROGRESS PROJECT																		
No.	Description		Week1	Week2	Week3	Week4	Week5	Week6	Week7	Week8	Week9	Week10	Week11	Week12	Week13	Week14	Week15	Week16
1	Introduction Course	Plan	■															
		Actual	☑															
2	Menentukan Tema	Plan		■	■													
		Actual		☑	☑													
3	Membuat Porposal	Plan				■	■											
		Actual				☑	☑											
4	Membuat Projek	Plan				■	■	■	■	■	■	■	■					
		Actual				☑	☑	☑	☑	☑	☑	☑	☑					
5	Uji Coba Alat Project	Plan												■	■			
		Actual												☑	☑			
6	Membuat Laporan Akhir	Plan														■	■	
		Actual														☑	☑	
7	Presentasi Akhir	Plan																■
		Actual																☑

**RS**  
**Data Sheet**

**Light dependent resistors**

**NORP12 RS stock number 651-507**  
**NSL19-M51 RS stock number 596-141**

Two cadmium sulphide (cdS) photoconductive cells with spectral responses similar to that of the human eye. The cell resistance falls with increasing light intensity. Applications include smoke detection, automatic lighting control, batch counting and burglar alarm systems.

**Guide to source illuminations**

Light source	Illumination (Lux)
Moonlight	0.1
60W bulb at 1m	50
1W MES bulb at 0.1m	100
Fluorescent lighting	500
Bright sunlight	30,000

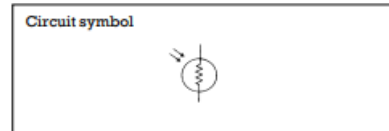

**Light memory characteristics**

Light dependent resistors have a particular property in that they remember the lighting conditions in which they have been stored. This memory effect can be minimised by storing the LDRs in light prior to use. Light storage reduces equilibrium time to reach steady resistance values.

**NORP12 (RS stock no. 651-507)**

**Absolute maximum ratings**

Voltage, ac or dc peak	320V
Current	75mA
Power dissipation at 30°C	250mW
Operating temperature range	-60°C to +75°C

**Electrical characteristics**

T<sub>A</sub> = 25°C. 2854°K tungsten light source

Parameter	Conditions	Min.	Typ.	Max.	Units
Cell resistance	1000 lux	-	400	-	Ω
	10 lux	-	9	-	kΩ
Dark resistance	-	1.0	-	-	MΩ
Dark capacitance	-	-	3.5	-	pF
Rise time 1	1000 lux	-	2.8	-	ms
	10 lux	-	18	-	ms
Fall time 2	1000 lux	-	48	-	ms
	10 lux	-	120	-	ms

1. Dark to 110% R<sub>L</sub>
  2. To 10 × R<sub>L</sub>
- R<sub>L</sub> = photocell resistance under given illumination.

**Features**

- Wide spectral response
- Low cost
- Wide ambient temperature range.

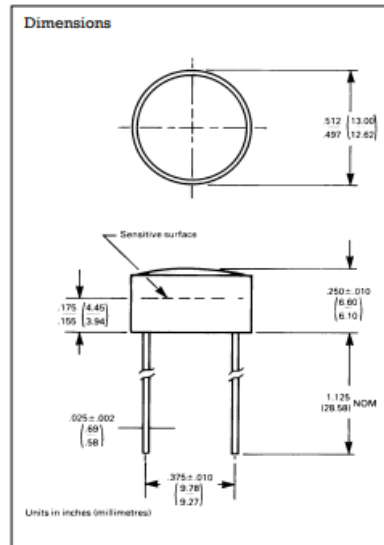

232-3816

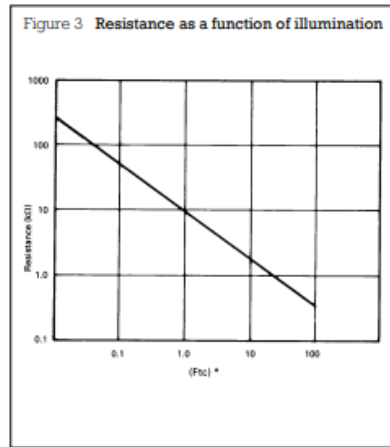
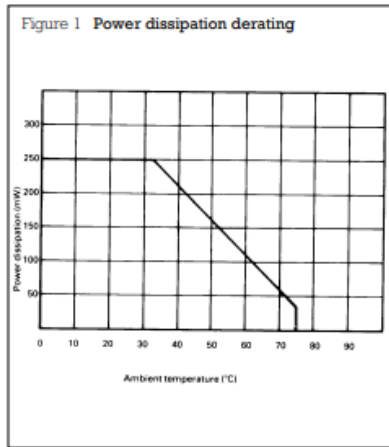

\*1Ftc=10.764 lumens

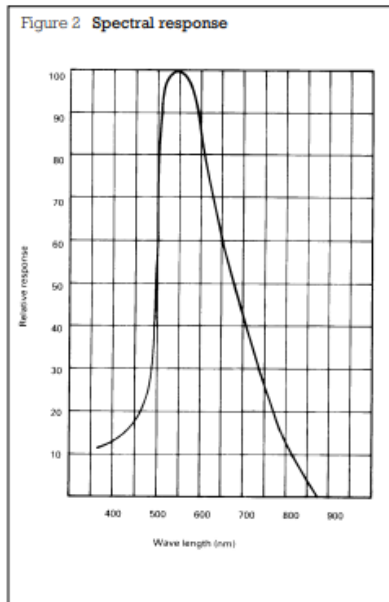

**Absolute maximum ratings**

Voltage, ac or dc peak \_\_\_\_\_ 100V  
 Current \_\_\_\_\_ 5mA  
 Power dissipation at 25°C \_\_\_\_\_ 50mW\*  
 Operating temperature range \_\_\_\_\_ -25°C +75°C

\*Derate linearly from 50mW at 25°C to 0W at 75°C.

**Electrical characteristics**

Parameter	Conditions	Min.	Typ.	Max.	Units
Cell resistance	10 lux	20	-	100	kΩ
	100 lux	-	5	-	kΩ
Dark resistance	10 lux after 10 sec	20	-	-	MΩ
Spectral response	-	-	550	-	nm
Rise time	10fc	-	45	-	ms
Fall time	10fc	-	55	-	ms

Figure 4 Resistance as a function illumination

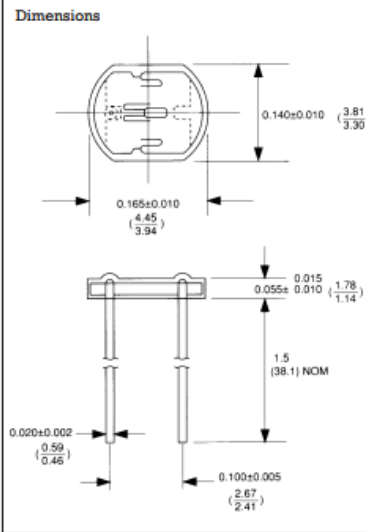
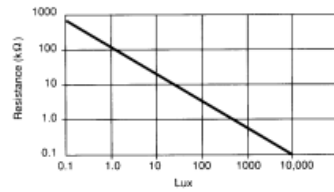
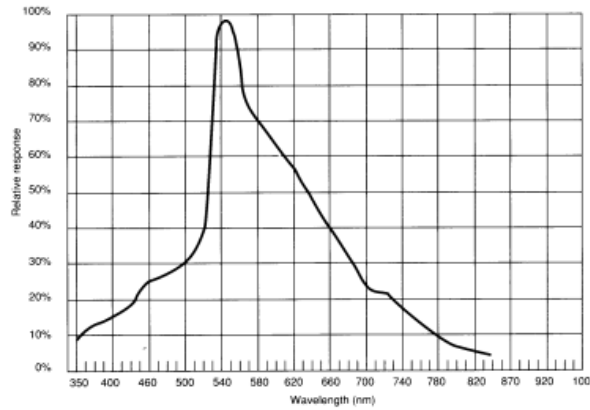
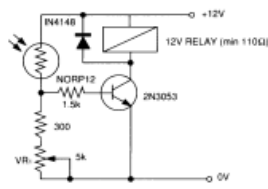

Figure 5 Spectral response



Typical application circuits

Figure 6 Sensitive light operated relay



Relay energised when light level increases above the level set by VR.

Figure 9 Logarithmic law photographic light meter

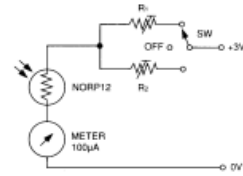

Typical value  $R^1 = 100k\Omega$   
 $R^2 = 200k\Omega$  preset to give two overlapping ranges.  
 (Calibration should be made against an accurate meter.)

Figure 7 Light interruption detector

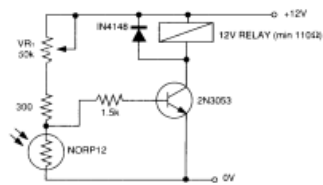

As Figure 6 relay energised when light level drops below the level set by VR.

Figure 10 Extremely sensitive light operated relay

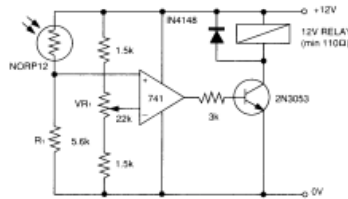

(Relay energised when light exceeds preset level.)  
 Incorporates a balancing bridge and op-amp.  $R_1$  and NORP12 may be interchanged for the reverse function.

Figure 8 Automatic light circuit

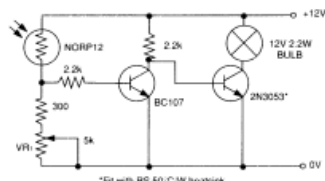

Adjust turn-on point with VR.

The information provided in RS technical literature is believed to be accurate and reliable, however, RS Components assumes no responsibility for inaccuracies or omissions, or for the use of this information, and all use of such information shall be entirely at the user's own risk. No responsibility is assumed by RS Components for any infringements of patents or other rights of third parties which may result from its use. Specifications shown in RS Components technical literature are subject to change without notice.

## Lampiran 3. Datasheet Raindrop Sensor

# VAISALA

www.vaisala.com

## YL-83 Rain Detector



Vaisala YL-83 Rain Detector

Rain and snow are quickly and accurately detected with the YL-83 Rain Detector. The YL-83 operates via droplet detection rather than by signal level threshold.

A special delay circuitry allows about two-minute interval between raindrops before assuming an OFF (no rain) position. This enables the sensor to accurately distinguish between rain cessation and light rain.

The YL-83 also features an analog Rain Signal for estimating rain intensity. Since this signal is proportional to the percentage of moist or wet area on the sensor plate, rain intensity has a direct impact on the amplitude and variation of this analog signal.

The YL-83 sensor is positioned at a 30° angle. This design, together with the internal heating element, ensures that the surface dries quickly, an essential factor in calculating intensity. The same heating element also protects the surface from fog and condensed moisture, and is activated at low temperatures in order to melt snow, thus allowing snow detection. Sensor performance is not affected by reasonable amounts of dirt and dust due to droplet detection.

It is intended to be used in areas with only rain or wet/moist snow precipitation.

### Features/Benefits

- Fast and accurate precipitation detection (ON/OFF)
- Rain intensity measurement with processing unit
- Maintenance free
- Heating element for keeping sensor free of snow and condensed moisture, and for quick drying



## Technical Data

### Sensor

Capacitive principle, thick layer sensor  
RainCap™ with a thin glass shield. Integrated heater element.

### Sensitivity of Rain Detection

Minimum wet area	0.05 cm <sup>2</sup>
OFF-delay (active)	< 5 min

### Physical

Sensor plate	
Sensing area	7.2 cm <sup>2</sup>
Angle	30°
Housing material	Polypropylene
Windshield and support bracket	Aluminum
Moisture shield	Polyurethane
Dimensions (h × w × l)	
With wind shield	110 × 80 × 175 mm
Without wind shield	90 × 46 × 157 mm
Weight	500 g
Cable length	4 m

### Electrical

Supply voltage	12 VDC ± 10 %
Supply current	
Typical less than	150 mA
Maximum	260 mA
Heater OFF	25 mA
Sensor plate	
Heating power	0.5 ... 2.3 W

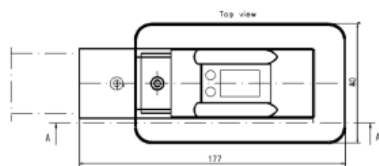

### Output

Rain ON/OFF	
Open collector, active low signal corresponds to rain	
Maximum voltage	15 V
Maximum current	50 mA
Analog output	1...3 V (wet...dry)
Frequency output	1500...6000 Hz, non-calibrated

### Input

Control to switch heater OFF	
Open circuit input enables the heater.	
Connection to GND disables the heater.	
Contact rating min.	15 V, 2 mA

### Ground Wiring

Separate ground wires for signal and heater

### Temperature Range

Operating	-15...+55 °C (+5...+131 °F)
Storage	-40...+65 °C (-40...+149 °F)

### Mounting

By one screw (M5 x 20 mm) to sensor arm

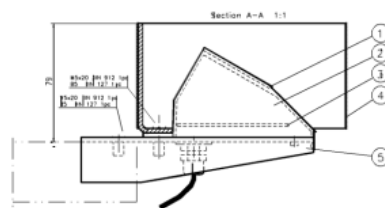

1. Sensor, RainCap™
2. Polyurethane moisture shield
3. Component assembly
4. Wind shield
5. Mounting plate

**VAISALA**

Please contact us at  
[www.vaisala.com/requestinfo](http://www.vaisala.com/requestinfo)



Scan the code for more information

Ref. B010018EN-B ©Vaisala 2015  
This material is subject to copyright protection, with all copyrights retained by Vaisala and its individual partners. All rights reserved. Any logos and/or product names are trademarks of Vaisala or its individual partners. The reproduction, translation, distribution or storage of information contained in this brochure in any form without the prior written consent of Vaisala is strictly prohibited. All specifications — technical included — are subject to change without notice.

[www.vaisala.com](http://www.vaisala.com)

CE

Lampiran 4. Harga Bahan Pembuatan Alat

No	Nama Barang	jumlah	Harga
1	Motor Driver ULN2003	1 Pcs	Rp 25,000
2	Arduino Nano + Kabel USB	1 Pcs	Rp 95,000
3	Lampu LED	1 Pcs	Rp 5,000
4	Stepper Motor 28BYJ-48	1 Pcs	Rp 20,000
5	Rain Drop Sensor	1 Pcs	Rp 15,000
6	Sensor LDR	1 Pcs	Rp 10,000
7	Kabel Male-Female	1 Set	Rp 26,000
8	Saklar Kecil	1 Pcs	Rp 4,000
9	Akrilik fullset	1 Set	Rp 85,000
10	Pulley + Hidler Pulley GT2	1 Set	Rp 70,000
11	Bahan Support ( Timah dan Lem)	1 Lot	Rp 20,000
12	Baterai 6V	1 Pcs	Rp 81,000
13	Modul Bluetooth	1 Pcs	Rp 35,000
Jumlah			Rp 491,000

## Lampiran 5. Program Coding

```
#include <SoftwareSerial.h>
SoftwareSerial BTSerial(3, 2);
#include <AccelStepper.h>
#define motorPin1 8
#define motorPin2 9
#define motorPin3 10
#define motorPin4 11
#define MotorInterfaceType 8
#define Home 4

int int_cahaya = A7;
int air = A6;
int stopper2 = A5;
int stopper1 = A4;
//String inval;

AccelStepper stepper = AccelStepper(MotorInterfaceType, motorPin1, motorPin3,
motorPin2, motorPin4);
const int bawah = 0;
const int atas = 1024;

void setup() {
  int val = 0;
  pinMode(int_cahaya, INPUT);
  pinMode(air, INPUT);
  pinMode(stopper1, INPUT_PULLUP);
  pinMode(stopper2, INPUT);
  pinMode(Home, OUTPUT);
  stepper.setMaxSpeed(900);
```

```

stepper.setAcceleration(800);
// BTSerial.setTimeout(10);
BTSerial.begin(9600);
Serial.begin(115200);
digitalWrite(Home, LOW);
// digitalWrite(Home, HIGH);
val = analogRead(stopper1);
delay(1);
val = analogRead(stopper1);
delay(1);
val = analogRead(stopper1);
delay(1);
Serial.print("val = ");
Serial.println(val);
if (val > 45) {
  int count = 0;
  //Serial.print("val = ");
  //Serial.println(val);
  // //Serial.println("Homing !!");
  while (val > 615) {
    count++;
    if (count >= 10000) {
      count = 0;
    } // //Serial.print("H val = "); //Serial.println(val);}
    // //Serial.println("Homing !!");
    val = analogRead(stopper1);
    stepper.setSpeed(900);
    stepper.runSpeed();
  }
  Serial.print("val = ");
  Serial.println(val );
}

```

```

    stepper.setCurrentPosition(0);
}

digitalWrite(Home, HIGH);
// Serial.print("HOMING DONE val = ");
// Serial.println(val);
}

void loop() {

    int sensor_air = analogRead(air);
    int sensor_cahaya = analogRead(int_cahaya);
    String inval;

    if (BTSerial.available()) {
        inval = BTSerial.read();
        // Serial.println(inval);
        // Serial.write(BTSerial.read());
        if ( inval == "254") { //Hujan
            // Serial.println(inval);
            // Serial.println("Pos 0 (Hujan)");
            stepper.runToNewPosition(0);
        }
        else if (inval == "238") { //cerah
            // Serial.println(inval);
            // Serial.println("Pos 1 (Cerah)");
            stepper.runToNewPosition(-24000);
        }
    }
    else {
        // Serial.print("Hujan :");

```

```
// Serial.print(sensor_air);
// Serial.print("\tCerah :");
// Serial.println(sensor_cahaya);
if (sensor_air <= 800) {
  // Serial.println("Pos 0 (Hujan)");
  stepper.runToNewPosition(0);
}
else if ((sensor_air >= 800) && (sensor_cahaya <= 800)) { //cerah
  // Serial.println("Pos 1 (Cerah)");
  stepper.runToNewPosition(-24000);
}
delay(1000);
}
}
```